

M-QFN56W.5
DWG 455650

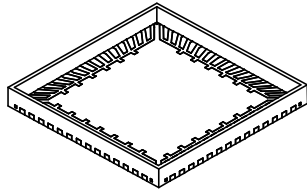

56L - 8X8mm
PITCH 0.5mm

M-QFN64W.5
DWG 456450

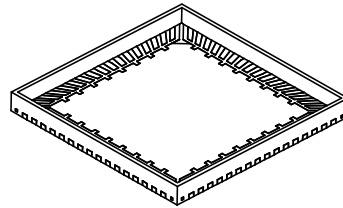

64L - 9X9mm
PITCH 0.5mm

M-QFN72W.5
DWG 457250

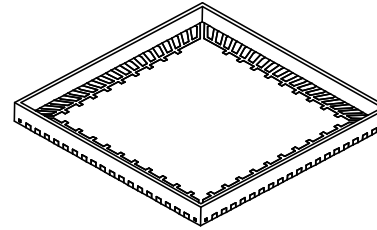

72L - 10X10mm
PITCH 0.5mm

M-QFN80W.5
DWG 458050

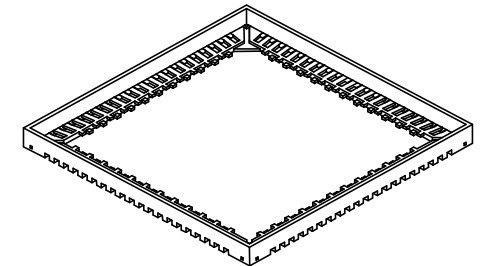

80L - 12X12mm
PITCH 0.5mm

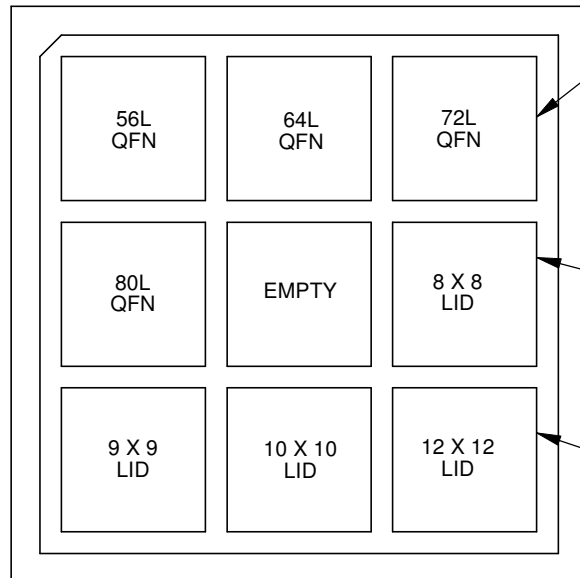

2-INCH WAFFLE PACK
TOP VIEW

M-QFN PACKAGES
OPEN CAVITY
1X EACH

WHITE LIDS
1X EACH
ROGERS RO4003C

BLACK LIDS
1X EACH
STACK WHITE
LID ON TOP OF
BLACK LID IN
SAME POCKET

KIT P/N 450002 - B.O.M. CONTENTS

QTY	DWG NBR	PART NUMBER	PINS	SIZE	PITCH	DESCRIPTION
1	455650	M-QFN56W.5	56L	8X8mm	0.5mm	OPEN (AIR) CAVITY QFN PACKAGE
1	456450	M-QFN64W.5	64L	9X9mm	0.5mm	
1	457250	M-QFN72W.5	72L	10X10mm	0.5mm	
1	458050	M-QFN80W.5	80L	12X12mm	0.5mm	
1	208942	T-LID8W-WHITE	--	8X8mm	--	FLAT LID ROGERS RO4003C WHITE
1	209942	T-LID9W-WHITE	--	9X9mm	--	
1	210942	T-LID10W-WHITE	--	10X10mm	--	
1	212942	T-LID12W-WHITE	--	12X12mm	--	FLAT LID BT BLACK
1	208102	T-LID8W-BLACK	--	8X8mm	--	
1	209102	T-LID9W-BLACK	--	9X9mm	--	
1	210102	T-LID10W-BLACK	--	10X10mm	--	
1	212102	T-LID12W-BLACK	--	12X12mm	--	

CONTACT:
MIRROR SEMICONDUCTOR
TEL: 1-866-404-8800
EMAIL: info@MirrorSemi.com
www.MirrorSemi.com

Notes: (Unless Otherwise Specified).

- 1) M-QFN OPEN (AIR) CAVITY PACKAGES.
- 2) PLATING: Ni/Pd/Au.
- 3) LEAD FRAME: Cu COPPER (C-194F/H).
- 4) BODY: PLASTIC SEMICONDUCTOR GRADE.
- 5) CONFORMS TO JEDEC OUTLINE.

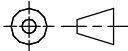
TOLERANCE UNLESS NOTED		APPROVALS	DATE	 TITLE M-QFN EVALUATION KIT OPEN CAVITY PACKAGES			
X.X	+/- 0.3	DRAWN J. Hines	7/31/2011				
X.XX	+/- 0.03			3.5:1	A	450002	A
X.XXX	+/- 0.003	ENG		DO NOT SCALE DRAWING			
ANGLES	+/- 0.5°	MFG					
ALL DIMENSIONS IN		QA					
<input checked="" type="checkbox"/> INCHES <input checked="" type="checkbox"/> MILLIMETERS		CUST					
THIRD ANGLE PROJECTION		REVISED					
							

M-QFN PACKAGE OUTLINE DRAWING

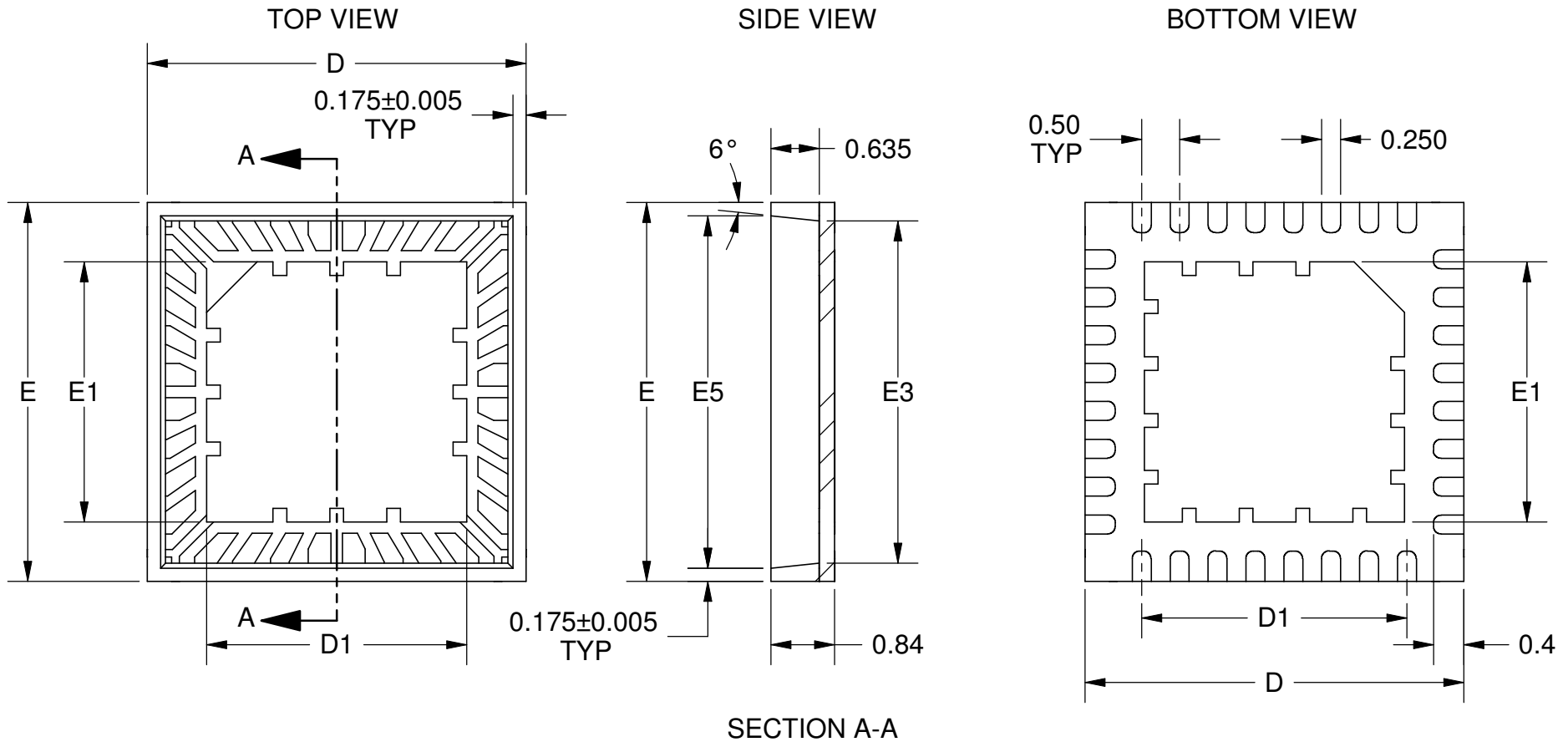

M-QFN PACKAGE OUTLINE (mm)						
DWG NBR	PART NUMBER	NBR PINS	E D	E1 D1	E3 D3	E5 D5
455650	M-QFN56W.5	56L	8	6.0	7.517	7.65
456450	M-QFN64W.5	64L	9	7.0	8.517	8.65
457250	M-QFN72W.5	72L	10	8.0	9.517	9.65
458050	M-QFN80W.5	80L	12	10.0	11.517	11.65

CONTACT:
 MIRROR SEMICONDUCTOR
 TEL: 1-866-404-8800
 EMAIL: info@MirrorSemi.com
 www.MirrorSemi.com

TITLE M-QFN EVALUATION KIT OPEN CAVITY PACKAGES			
SCALE 12:1	SIZE A	DRAWING NO. 450002	REV A
DO NOT SCALE DRAWING		SHEET 2 OF 4	

M-QFN80
80L

79 77 75 73 71 69 67 65 63 61
80 78 76 74 72 70 68 66 64 62

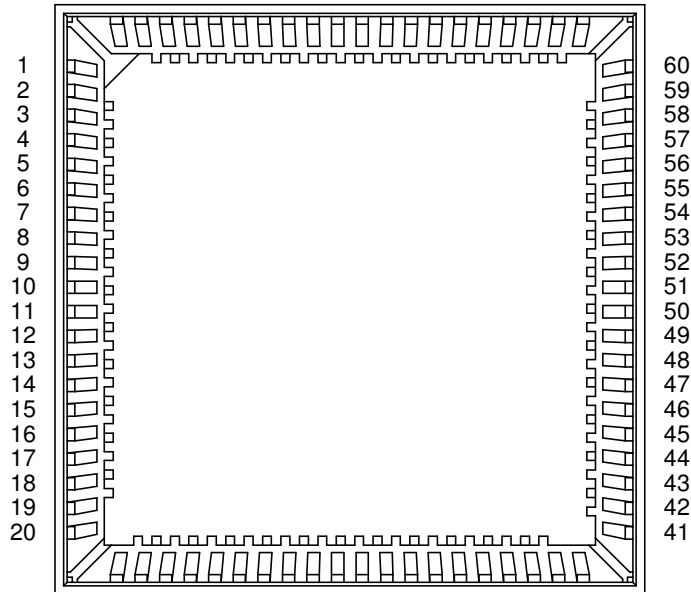

21 23 25 27 29 31 33 35 37 39
22 24 26 28 30 32 34 36 38 40

M-QFN72
72L

71 69 67 65 63 61 59 57 55
72 70 68 66 64 62 60 58 56

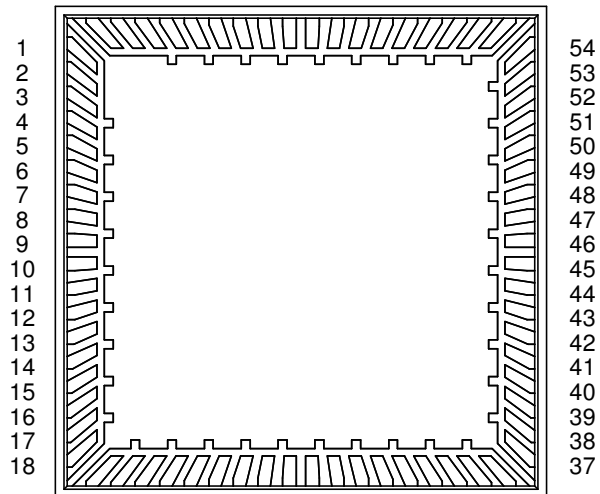

20 22 24 26 28 30 32 34 36
19 21 23 25 27 29 31 33 35

M-QFN64
64L

63 61 59 57 55 53 51 49
64 62 60 58 56 54 52 50

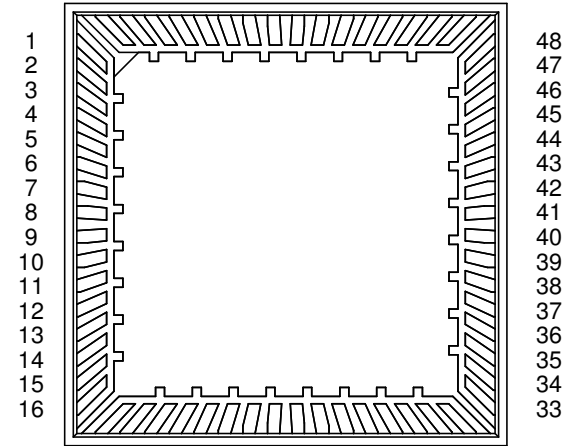

17 19 21 23 25 27 29 31
18 20 22 24 26 28 30 32

M-QFN56
56L

55 53 51 49 47 45 43
56 54 52 50 48 46 44

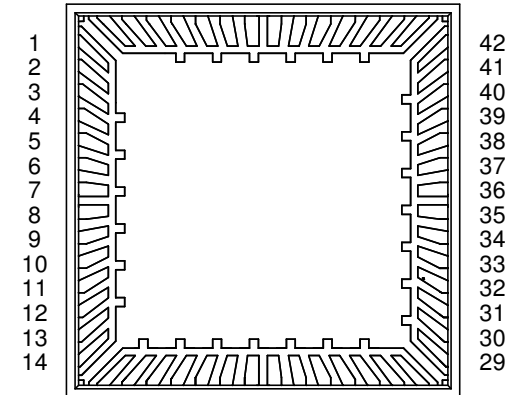

15 17 19 21 23 25 27
16 18 20 22 24 26 28



TITLE M-QFN EVALUATION KIT
OPEN CAVITY PACKAGES

SCALE 6.5:1	SIZE A	DRAWING NO. 450002	REV A
----------------	-----------	-----------------------	----------

DO NOT SCALE DRAWING

SHEET 3 OF 4

FLAT LID (TAPE ON)

TOP VIEW

SIDE VIEW

BOTTOM VIEW

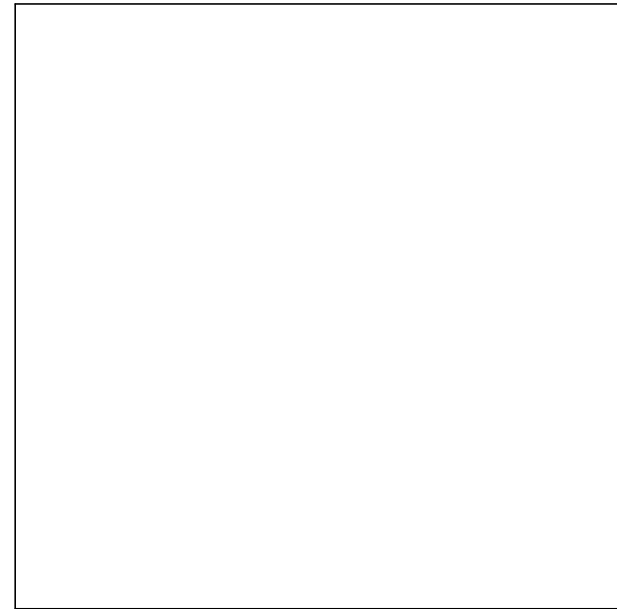
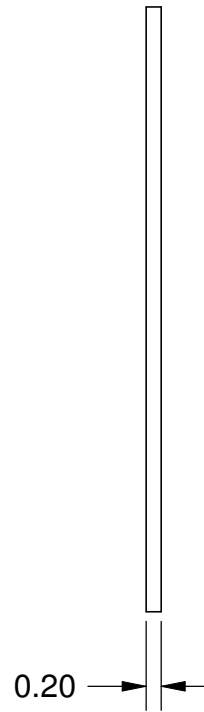
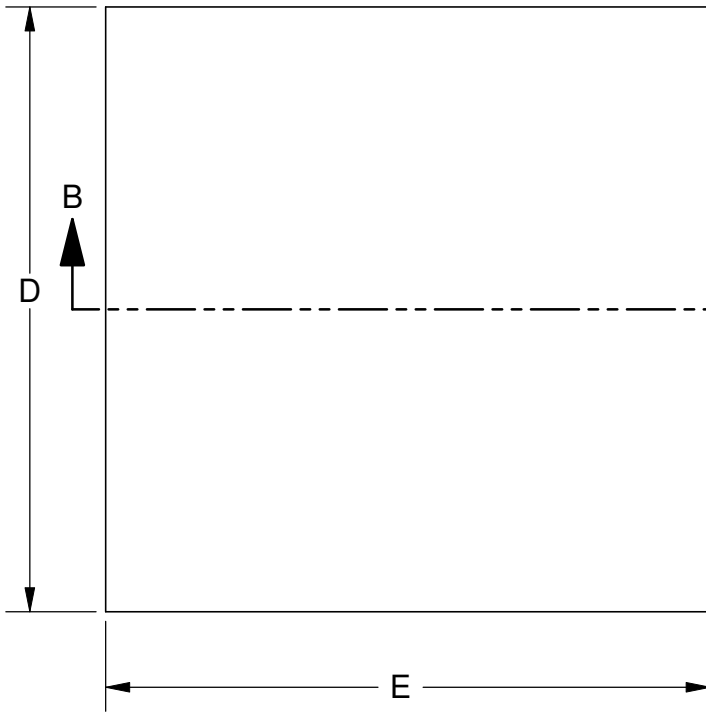

SECTION B-B

Notes: (Unless Otherwise Specified).

- 1) MATERIAL:
 - A) LID: ROGERS RO4003C = WHITE, BT = BLACK.
 - B) PREFORM: NONE.
- 2) LID ATTACH:
 - REMOVABLE: USE KAPTON TAPE OR EQUIVALENT.
 - PERMANENT: USE EPOXY PER CUSTOMER CHOICE.
- 3) STORAGE LIFE: NO LIMIT @ 25°C.
- 4) COLOR:
 - STANDARD: WHITE OR BLACK.

DIMENSION TABLE (mm)					
QFN SIZE	D/E	DWG	PART NBR	DWG	PART NBR
8X8	8.0	208942	T-LID8W-WHITE	208102	T-LID8W-BLACK
9X9	9.0	209942	T-LID9W-WHITE	209102	T-LID9W-BLACK
10X10	10.0	210942	T-LID10W-WHITE	210102	T-LID10W-BLACK
12X12	12.0	212942	T-LID12W-WHITE	212102	T-LID12W-BLACK

			
TITLE M-QFN EVALUATION KIT OPEN CAVITY PACKAGES			
SCALE 10:1	SIZE A	DRAWING NO. 450002	REV A
DO NOT SCALE DRAWING		SHEET 4 OF 4	