

TOP VIEW
OPEN SIDE

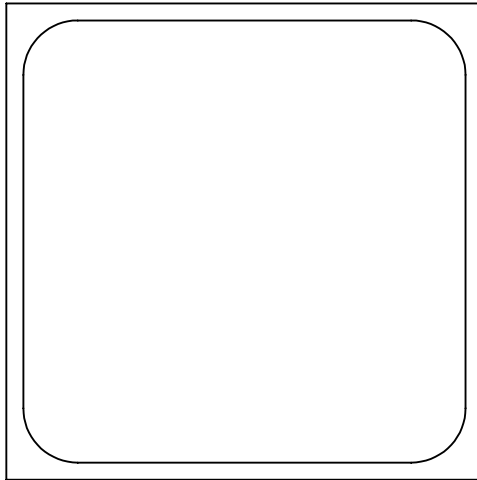

SIDE VIEW

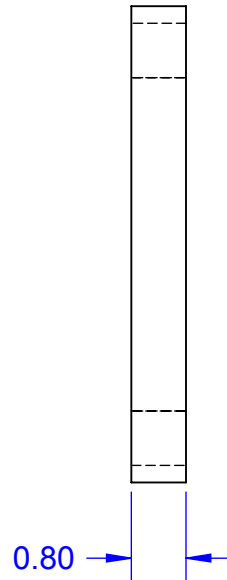

BOTTOM VIEW
OPEN SIDE

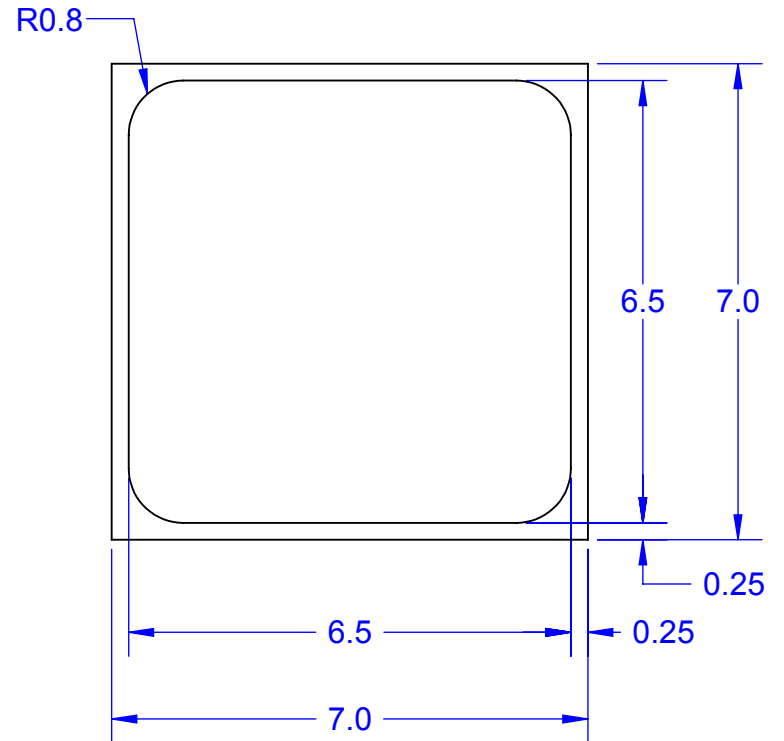

Notes: (Unless Otherwise Specified).
 1) MATERIAL: BT BLACK.
 2) DIMENSIONS IN mm.

APPROVALS		DATE	 Mirror Semiconductor™			
DRAWN	T. Au	10/17/2012				
ENG	M. Hart	10/17/2012	TITLE			
MFG			EXT 7x7mm CAVITY EXTENDER			
QA			SCALE	SIZE	DRAWING NO.	REV
CUST			10:1	A	207109	A
REVISED			DO NOT SCALE DRAWING			SHEET 1 OF 1