

TOP VIEW  
OPEN SIDE

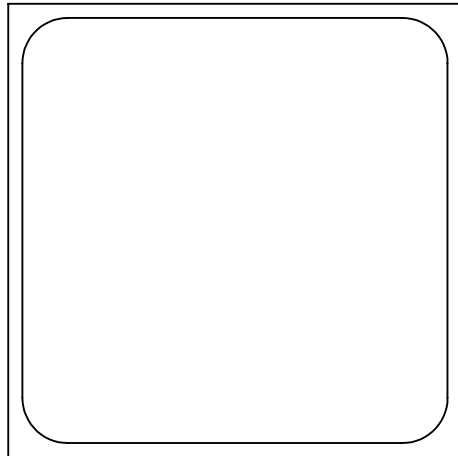

SIDE VIEW

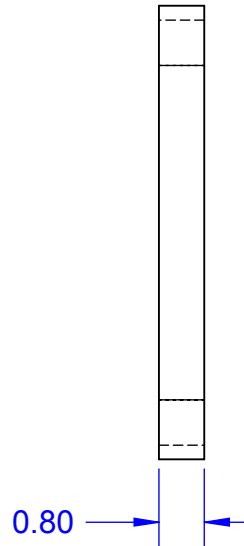

BOTTOM VIEW  
OPEN SIDE

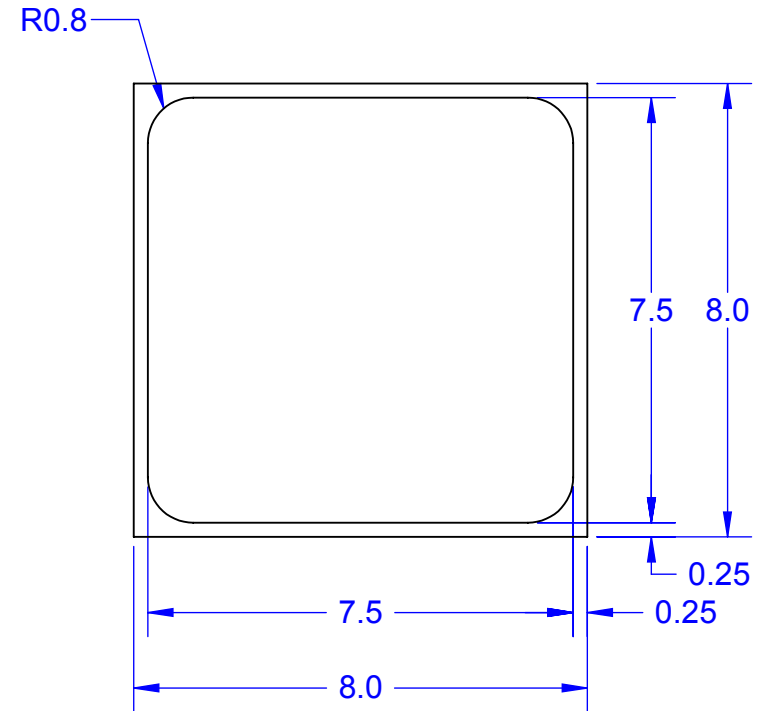

Notes: (Unless Otherwise Specified).  
 1) MATERIAL: BT BLACK.  
 2) DIMENSIONS IN mm.

APPROVALS		DATE	 Mirror Semiconductor™			
DRAWN	T. Au	10/17/2012				
ENG	M. Hart	10/17/2012	TITLE			
MFG			EXT 8x8mm CAVITY EXTENDER			
QA			SCALE	SIZE	DRAWING NO.	REV
CUST			9:1	A	208109	A
REVISED			DO NOT SCALE DRAWING			SHEET 1 OF 1